



4184 E. Conant st., Long Beach, CA 90808
 Tel. 800-500-3519 Fax. 310-900-1066
www.turboairinc.com

Project :

Model # :

Item # :

Qty :

Available W/H :

Approval :

48" Wide Heavy Duty Restaurant Ranges

**Model : TAR-8
 TAR-8-LP**



≡ FEATURES & BENEFITS ≡

- Heavy gauge welded frame construction
- Fully adjustable oven thermostat providing temperatures from 250-550°F degrees
- Stainless steel front, sides, back riser lift-off high shelf
- Pull out stainless steel door for easy cleaning
- Individual pilot for each lift off top open burner at 32,000 btu/hr
- Thermostat controlled griddle
- 6" stainless steel adjustable legs (casters available as an option)
- 1 stainless steel oven rack standard (additional racks optional)
- 12" x 12" sectioned heavy duty cast iron grates
- CSA certified for safety / sanitation for USA and Canada
- Full size pull out crumb tray
- Wrap around full stainless steel oven interior / 26.3" depth standard



Model	Oven	Weight (lbs.)	Width (inches)	Total BTUs	Configuration
TAR-8	2	675	48	326K	8 Open Burners (NAT)
TAR-8-LP	2	675	48	320K	8 Open Burners (LPG)

48" Wide Heavy Duty Restaurant Ranges

Model : TAR-8

DATA	TAR-8
Gas Type	NAT
Gas Connection	3/4"
Regulator	3/4"
Gas Pressure	5 W.C"
BTU	326,000
DIMENSIONAL DATA	
Ext. Length Overall (inch)	48 (1219mm)
Ext. Depth Overall (inch)	31 7/8 (810mm) + manifold
Ext. Height Overall (inch)	56 1/2 (1436mm)
OVEN DIMENSION (Interior)	
Number of Oven	2
Length (inch)	20 1/8 (510mm)
Depth (inch)	26 1/4 (669mm)
Height (inch)	13 5/8 (345mm)
Weight (lbs.)	675

DATA	TAR-8-LP
Gas Type	LPG
Gas Connection	3/4"
Regulator	3/4"
Gas Pressure	10 W.C"
BTU	320,000
DIMENSIONAL DATA	
Ext. Length Overall (inch)	48 (1219mm)
Ext. Depth Overall (inch)	31 7/8 (810mm) + manifold
Ext. Height Overall (inch)	56 1/2 (1436mm)
OVEN DIMENSION (Interior)	
Number of Oven	2
Length (inch)	20 1/8 (510mm)
Depth (inch)	26 1/4 (669mm)
Height (inch)	13 5/8 (345mm)
Weight (lbs.)	675

Design and specifications subject to change without notice.
Actual shipping weight may differ due to extra packing materials for product protection.

■ WARRANTY : 1 Year Labor and Parts Warranty

■ OPTIONAL ACCESSORIES :

- Casters (Set of 4)
- Stainless steel oven racks

PLAN VIEW

(unit : inch)

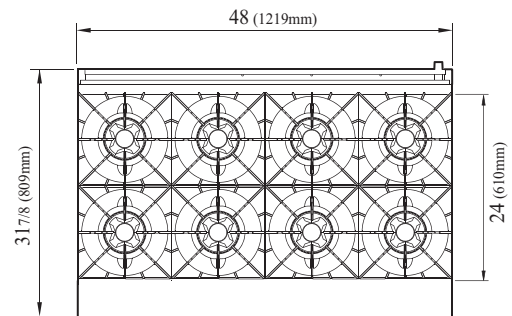

TOP VIEW

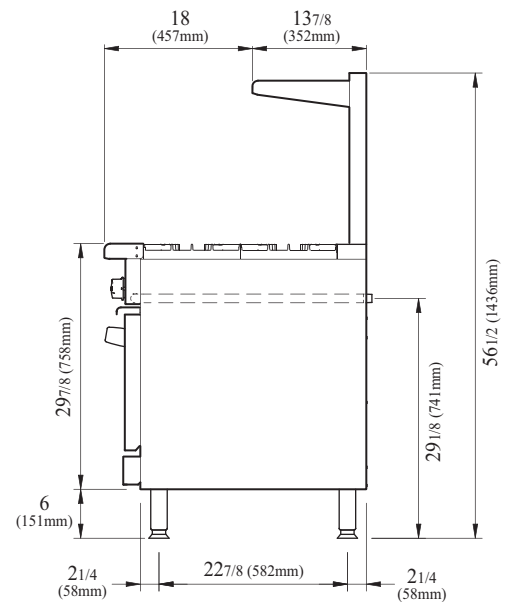

SIDE VIEW

Ver.201601



- Turbo Air : 800-627-0032 ■ GK : 800-500-3519
- Warranty : 800-381-7770 ■ AC : 888-900-1002