



ITEM NO. _____
 PROJECT _____
 LOCATION _____
 DATE _____ QTY. _____

NLMC SERIES

Single Access Milk Coolers

MODELS

- NLMC08S*
- NLMC12S*
- NLMC16S*

*Add suffix "W" for white finish, "S" for stainless steel



NLMC12SW

NLMC12SS



FEATURES

CONSTRUCTION

- White enamel painted smooth steel exterior with stainless steel interior
- Corner bumpers
- Four 4" factory-installed easy-roll swivel casters (two locking)
- Epoxy-coated heavy-duty floor racks
- NSF-listed digital thermometer
- Foamed-in-place eco-friendly polyurethane insulation
- Doors and cabinet top foamed-in-place with polyurethane insulation
- Standard floor drain

DOORS

- Self service doors with stainless steel exterior and interior
- Fold-back, insulated doors equipped with locks, gaskets and stainless steel hinges
- Designed to be easily opened by children for self-service

REFRIGERATION

- Self-contained bottom mounted system with air-cooled condensing unit
- Powerful, large-capacity system allows cooler to quickly pull product down to storage temperature and maintain it
- Cold wall evaporator with no moving parts which allows more storage space
- Refrigerant: R290
- Operating temperature: 34° to 40°F (1° to 4°C)

WARRANTY

- Standard limited three year parts and labor
- Additional two year coverage on compressor part

OPTIONS

- Add suffix "S" for all stainless steel exterior



NLMC SERIES
SINGLE ACCESS MILK COOLERS

TECHNICAL SPECIFICATIONS

Model*	NLMC08S*	NLMC12S*	NLMC16S*
Crated Weight (lbs.) (kg)	165 (75)	212 (96)	243 (110)
Crated Height (in) (mm)	48.6 (1234)	48.6 (1234)	48.6 (1234)
Crated Width (in) (mm)	35.8 (909)	50.8 (1290)	59.8 (1519)
Crated Depth (in) (mm)	32.3 (820)	32.3 (820)	32.3 (820)
Interior Height (in) (mm)	25.2 (640)	25.2 (640)	25.2 (640)
Interior Width (in) (mm)	30.9 (785)	45.9 (1166)	54.9 (1394)
Interior Depth (in) (mm)	26.5 (673)	26.5 (673)	26.5 (673)
Overall Height (in) (mm)	42 (1067)	42 (1067)	42 (1067)
Overall Width (in) (mm)	34 (865)	49 (1245)	58 (1475)
Overall Depth (in) (mm)	30.6 (777)	30.6 (777)	30.6 (777)
Gross Cubage (CuFt) (L)	13.2 (374)	19.6 (555)	23.5 (665)
Number of Floor Racks	2	2	2
Number of Casters	4	4	4
Condensing Unit Size	1/4 HP	1/4 HP	1/4 HP
Refrigerant	R290	R290	R290
Electrical Characteristics	115/60/1	115/60/1	115/60/1
Nema Plug Configuration	5-15P	5-15P	5-15P
Total Amp Draw	3.0	3.0	3.0

MODEL	CASES WITH CARTONS			
	13" x 13" x 11"H		19" x 13" x 11"H	
	CASES	CARTONS	CASES	CARTONS
NLMC08S*	8	352	4	288
NLMC12S*	12	528	8	576
NLMC16S*	16	704	10	720

MODEL	LOOSE CARTON (WITHOUT CASES)			
	FLAT TOP		PEAKED TOP (GABLE)	
	1/2 PINT	1 PINT	1/2 PINT	1 PINT
NLMC08S*	864	432	680	430
NLMC12S*	1368	684	1020	645
NLMC16S*	1800	900	1360	860

* Add suffix "W" for white exterior, "S" for stainless steel.

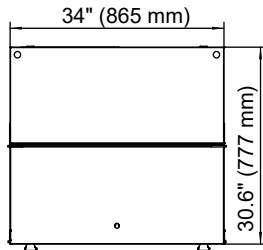

NLMC08S* PLAN VIEW

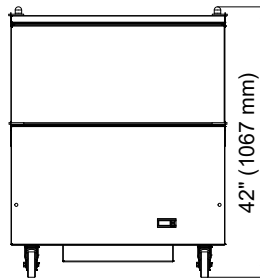

NLMC08S* ELEVATION VIEW

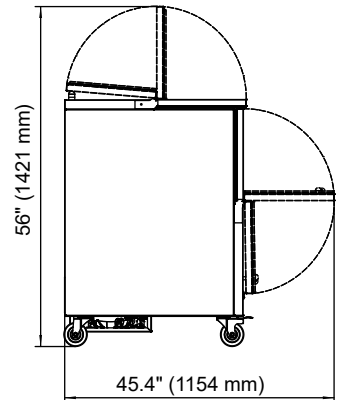

**SIDE VIEW
ALL MODELS**

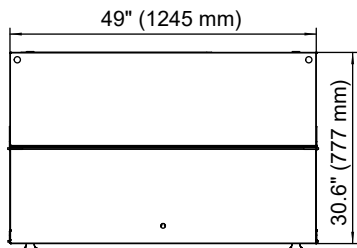

NLMC12S* PLAN VIEW

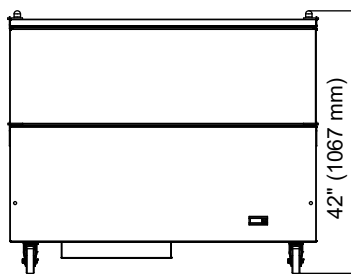

NLMC12S* ELEVATION VIEW

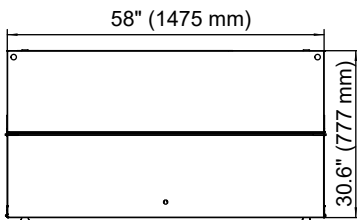

NLMC16S* PLAN VIEW

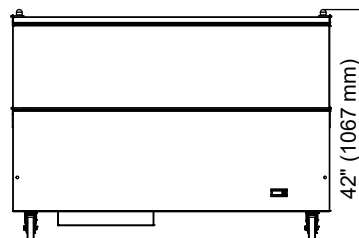

NLMC16S* ELEVATION VIEW



NLMC SERIES SINGLE ACCESS MILK COOLERS

LISTINGS



HOOKUP

Via plug in, 9.8 foot long flexible three wire 14/3 cord with molded plug.



BID SPECIFICATIONS

Item no. NLMC _____
Provide _____ ()
Single Access Milk Cooler(s),
Norlake model no. NLMC _____.

Milk cooler will be a single access type and will be constructed of white painted steel exterior with stainless steel interior. Doors to be stainless steel on the exterior and interior. Doors will also be locking and fold-

back type. In addition, door will be equipped with gaskets, stainless steel hinges and a hold-open feature to secure during serving.

Cooler to be provided with four swivel casters (two locking) and an NSF-listed digital thermometer. Cabinet insulation will consist of foamed-in-place polyurethane.

The self-contained refrigeration

system will feature a cold wall evaporator and R290 refrigerant. The operating temperature will 34° to 40°F (1° to 4°C).

Cooler to have standard limited three year parts and labor with an additional two year coverage on compressor part.

Cooler to be ETL listed in the U.S. and Canada and ETL Sanitation listed.

**NOTE: Cabinet designed for optimum performance in air-conditioned area at 75°F ambient and 55% relative humidity.
All specifications within this publication subject to change without notice.**

