



# ELEVATION SERIES CUBE ICE MAKER

## CIM2046/2047



CIM2046 ON B110

### Features

- Space-saving 26.8" (681 mm) tall design.
- Produces up to 1,860 lbs (844 kg) of ice per day.
- *Harvest Assist* provides consistent ice production for the life of the ice maker while reducing energy consumption and increasing capacity.
- *Pure Ice*® exclusively by Ice-O-Matic. Built-in antimicrobial protection for the life of the ice maker inhibits bacteria growth on ice maker surfaces. Ice-O-Matic's optional water filtration system provides protection against unpleasant tastes, odors and scale formation.
- Durable, electroless nickel plating on all evaporator plates ensures reliability.
- *Longest warranty in the industry.* Purchase an Ice-O-Matic water filter with your cube ice maker, replace the filter every six months, and the evaporator warranty is extended to 7 years parts and labor (available in the U.S. and Canada only).
- Constructed from corrosion-resistant aluminum and fingerprint-proof plastic.

### Options & Accessories

WATER FILTERS			
Ice Machine Model	Manifold		Inline
	System	Replacement	System
CIM2046	IFQ2	IOMQ (2)	N/A
CIM2047			

### Ice Maker Warranty

Every Ice-O-Matic ice maker is backed by a warranty that provides both parts and labor coverage.

- Three years **Parts** and **Labor**.
- Five years **Parts** coverage on the evaporator and compressor.
- Seven years **Parts** and **Labor** on the evaporator when you purchase an Ice-O-Matic water filter with your cube ice maker and replace the filter every six months (available in the U.S. and Canada only).

### Ice Form



#### CUBE

FULL CUBE DIMENSIONS	
W x D x H (in.)	7 $\frac{1}{8}$ x 7 $\frac{1}{8}$ x 7 $\frac{1}{8}$
W x D x H (mm)	22 x 22 x 22
HALF CUBE DIMENSIONS	
W x D x H (in.)	3 $\frac{1}{8}$ x 7 $\frac{1}{8}$ x 7 $\frac{1}{8}$
W x D x H (mm)	10 x 22 x 22

### Bin Chart Kits for Combining Wider Bins with Smaller Models

ICE STORAGE BINS										
Model No.	B25	B40	B42	B55	B700	B1000	B110	B1300	B1325	B1600
Capacity	242 lbs (110 kg)	344 lbs (156 kg)	351 lbs (160 kg)	510 lbs (232 kg)	680 lbs (308 kg)	1000 lbs (454 kg)	854 lbs (388 kg)	1320 lbs (599 kg)	1325 lbs (601 kg)	1660 lbs (753 kg)
Width	30 in (762 mm)	30 in (762 mm)	22 in (559 mm)	30 in (762 mm)	30 in (762 mm)	48 in (1,219 mm)	48 in (1,219 mm)	48 in (1,219 mm)	60 in (1,524 mm)	60 in (1,524 mm)
Kits	N/A						Kit Not Required			
CIM2046										
CIM2047										

See Ice-O-Matic Price List for Adapter Kits to combine ice makers with most available ice/beverage dispensers.



# ELEVATION SERIES CUBE ICE MAKER

## CIM2046/2047



CIM2046/2047 CUBE ICE MAKER

### Air Cooled

Please note: air-cooled units require 6" (152 mm) clearance for air intake and exhaust.

- A. Ice maker potable water in, 3/8" FPT.
- B. Ice maker water out, 3/4" FPT.
- C. Hole for electrical connections, 7/8".
- D. Electrical junction box.

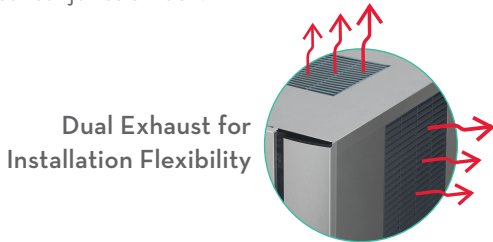

Air Cooled

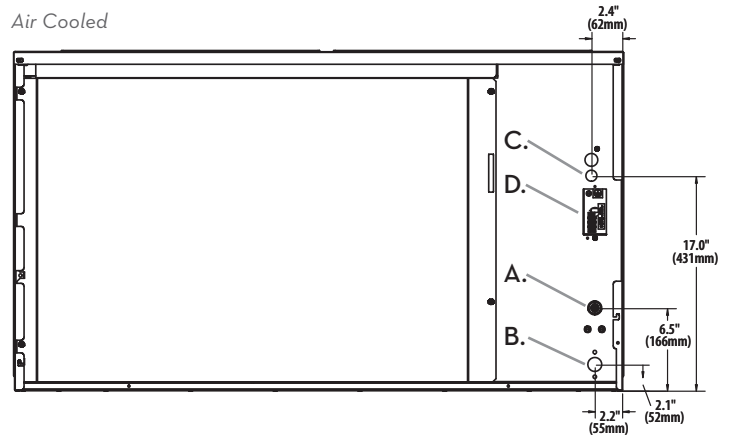

### Water Cooled/Remote

- A. Ice maker potable water in, 3/8" FPT.
- B. Ice maker water out, 3/4" FPT.
- C. Hole for electrical connections, 7/8".
- D. Electrical junction box.
- E. Condenser water in, 3/8" FPT (water only).
- F. Condenser water out, 1/2" FPT (water only).
- G. Liquid line, 3/8" male quick connect coupling for precharged line set (remote only).
- H. Discharge line, 1/2" male quick connect coupling for precharged line set (remote only).
- I. Hole for remote electrical connections, 7/8" (remote only).

Water Cooled & Remote

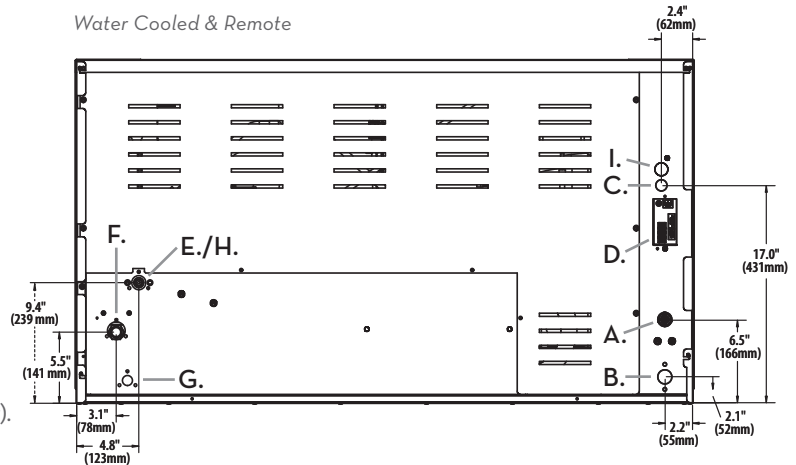

### Operating Requirements

	MINIMUM	MAXIMUM	
		60 Hz	50Hz
Ambient Temp. Range Air	50°F (10°C)	100°F (38°C)	110°F (43°C)
Water Temp.	40°F (4.4°C)		
Water Pressure	20 PSIG (1.4 BAR)	60 PSIG (4.1 BAR)	

### Dimensions

ALL MODELS	
W x D x H (in.)	48.25 x 24.25 x 26
W x D x H (mm)	1,226 x 616 x 660

### Specifications

Model Number	Cond. Unit	Ice Production per 24hrs		Water Usage gallons per 100 lbs of Ice 90°F air/70°F water		kWH Used per 100 lbs of ice @ 90°F air/70°F water	Voltage Characteristics	Min. Circuit Ampacity	Min/Max Fuse Size	Approx. BTUs per hour
		70°F air/50°F water lbs (kg)	90°F air/70°F water lbs (kg)	Potable	Condenser					
CIM2046A	Air	1,810 (821)	1,470 (667)	14.9	N/A	4.62	208-230/60/1	25.6	30/35	30,000
CIM2046R	Remote*	1,830 (830)	1,580 (717)	14.9	N/A	4.31		25.6		20,000
CIM2046W	Water	1,860 (844)	1,690 (767)	14.8	134.2	3.52		24.0		20,000
CIM2047A	Air	1,810 (821)	1,470 (667)	14.9	N/A	4.62	208-230/60/3	25.6	30/35	30,000
CIM2047R	Remote*	1,830 (830)	1,580 (717)	14.9	N/A	4.31		25.6		20,000
CIM2047W	Water	1,860 (844)	1,690 (767)	14.8	134.2	3.52		24.0		20,000

Daily ice production based on half cube configuration.

\* Remote model CIM2046R and CIM2047R require the RCA-3561 remote condenser with optional grill guard kit.

Notes:

Number of Wires: 3 (including ground)

Approx. Shipping Weight lbs (kg): CIM2046A 335 (152) • CIM2046R 335 (152) • CIM2046W 335 (152) • CIM2047A 335 (152) • CIM2047R 335 (152) • CIM2047W 335 (152)

Refrigerant Type: R404A

**B55**

## Features

- Application storage capacity from 242 lbs (110 kg) to 854 lbs (388 kg).
- Multiple bin tops provide an easy solution for mounting ice makers on different sized bins.
- Polyethylene bin liner is insulated with foam for maximum ice preservation – 1.5" to 3" (38 mm to 76 mm).
- 31" deep for use where space is at a premium.
- Built-in ice scoop holders on certain models.
- Sturdy leg design – 6" (152 mm) adjustable NSF approved legs – standard.
- Durable aluminum finish.

SLOPE FRONT STORAGE BINS

## Bin Accessories

Ice-O-Matic Part Number	Description
1011517-22	Plastic ice shovel
1011517-23	Hanging bracket for ice shovel
1011517-24	46.5" Plastic paddle
1051517-29	Hanging bracket for ice paddle
9051127-01	82 Ounce ice scoop

## Ordering and Specification Information – Required Bin Top/Cover

Bin Model No.	Application Bin Storage lbs (kgs)	Approximate Shipping Weight lbs (kgs)	ICE Series™ Cube Ice Makers			Nugget Ice Makers	Flake Ice Makers
			22" (559 mm) wide	30" (762 mm) wide	48" (1,219 mm) wide	21" (533 mm) wide	21" (533 mm) wide
B25PP*	242 (110)	74 (34)	KBT19	■ ■	N/A	KBT19	KBT19
B4OPS	344 (156)	103 (47)	KBT19	■ ■	N/A	KBT19	KBT19
B42PS	351 (160)	99 (45)	■ ■	N/A	N/A	KBT24	KBT24
B55PS	510 (232)	125 (57)	KBT19	■ ■	N/A	KBT19	KBT19
B11OPS	854 (388)	163 (74)	N/A	BPF-1	■ ■	KBT23	KBT23

■ ■ Kit not required. Hold down securement recommended.

Bin Height includes 6" (423 mm) legs. All bins have polyethylene liners.

\*Rotocast finish

## Ordering and Specification Information – Side by Side

Bin Model No.	Style	Application Bin Storage lbs (kgs)	Approximate Shipping Weight lbs (kgs)	ICE Series™ Cube Ice Makers			Nugget Ice Makers	Flake Ice Makers
				Two 22" (559 mm) wide	Two 30" (762 mm) wide	Two 48" (1,219 mm) wide	Two 21" (533 mm) wide	Two 21" (533 mm) wide
B25PP*	Slope Front	242 (110)	74 (34)	N/A	N/A	N/A	N/A	N/A
B4OPS	Slope Front	344 (156)	103 (47)	N/A	N/A	N/A	N/A	N/A
B42PS	Slope Front	351 (160)	99 (45)	N/A	N/A	N/A	N/A	N/A
B55PS	Slope Front	510 (232)	125 (57)	N/A	N/A	N/A	N/A	N/A
B11OPS	Slope Front	854 (388)	163 (74)	N/A	N/A	N/A	KBT22	KBT22

\*Rotocast finish



SLOPE FRONT STORAGE BINS

Dimensions

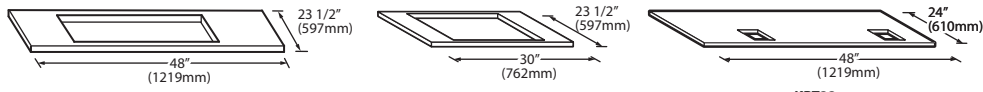
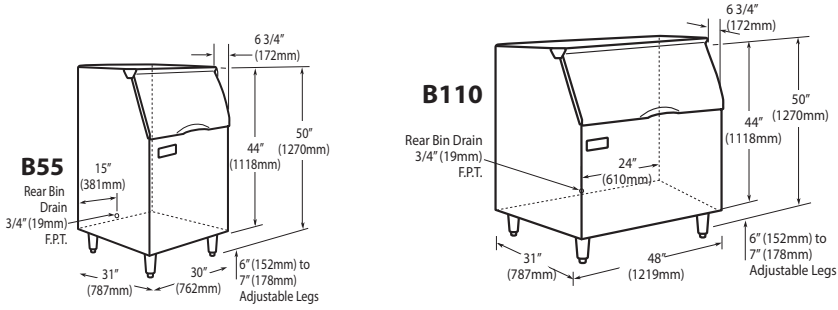
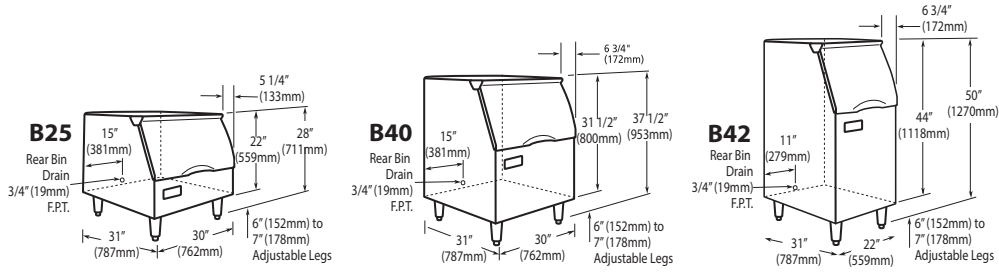

**KBT5**  
Bin Top for 30" (762 mm) ICE series cuber including the ICE1506 family on a B100 bin

**KBT19**  
Bin Top for 30" (762mm) bins with 22" (559mm) ICE Series Cube Ice Makers GEM Series Ice Makers & MFI Series Ice Makers

**KBT22**  
Bin Top for 48" (1219mm) bins with (2) 21" (533mm) wide GEM Series Ice Makers & MFI Series Ice Makers

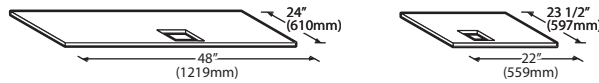

**KBT23**  
Bin Top for 48" (1219mm) bins with (1) 21" (533mm) wide GEM Series Ice Makers & MFI Series Ice Makers

**KBT24**  
Bin Top for 22" (559mm) bins with (1) 21" (533mm) wide GEM Series Ice Maker

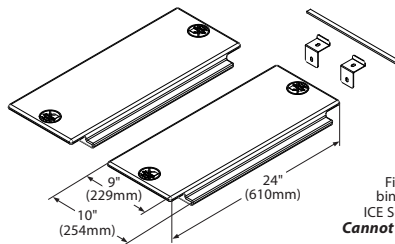

**BPF-1**  
Filler Panel for B110 bins with 30" (762mm) ICE Series Cube Ice Makers  
**Cannot be used with the B100**

NOTES:

Approx. Shipping Weight lbs (kg): B110 191 (87 kg) • B55 170 (77 kb) • B25 95 (43 kg) • B40 135 (61 kg) • B42 135 (61 kg)