



USER MANUAL

ELECTRIC FORKLIFT STACKER



MODEL: HILO-ES



USR Brands, Inc.

Phone: 800-764-1172 | www.usrestaurant.com | sales@usrestaurant.com

CONTENT

1.	TECHNICAL DATA	1
2.	WARNING	2
3.	NOTICE	3
4.	CONTROL PART	4
4.1	Emergency stop button	4
4.2	Key switch	4
4.3	Control handle	4
4.4	Voltammeter	5
4.5	Battery	5
5.	STACKER INSPECTION	6
5.1	Running stacker over and over again	6
5.2	Running stacker at wide-open area	6
5.3	Check hydraulic oil	6
5.4	Check battery	6
6.	STACKER OPERATING INSTRUCTIONS	6
6.1	Power unit	6
6.2	Start	7
6.3	Driving	7
6.4	Slow down	7
6.5	Brake	7
6.6	Lifting and lowering	7
6.7	Unload	8
6.8	Load	8
6.9	Storage	8
6.10	Long-term parking	8
7.	MAINTENANCE	8
7.1	Repair summer	8
7.2	Announcement	8
7.3	Maintenance	9
8.	BATTERY SERVICE AND MAINTENANCE	10
9.	MALFUNCTION ANALYSIS AND SOLUTION	11

Warning

Please read this instruction manual carefully before using the HILO-ES electric stacker.

This manual works for all HILO-ES electric stacker, and we reserve our rights for technical reform. Pictures and object maybe slightly different, please in kind prevail.

HILO-ES Electric Stacker Series

Note:

The usage and choice of electric stacker:

1. The stacker should be used on the flat and solid ground.
2. The stacker could be used on factory, logistics center, distribution center, warehouse, port, market and etc.
3. Please choose full electric stacker when it is used for containers encasement.
4. Please make sure that there are enough space between two shelves when load or unload goods on shelves.
5. Please read instructions carefully.

1. TECHNICAL DATA

Articles/model	Unit	HILO-ES
Dive mode	QD	Electric
Driving mode	JS	Stand/Step
loading capacity	lb	3300
Load center distance	in	21.6
Wheel material	PU	Polyurethane
Front wheel	mm	φ80*70
Rear wheel	mm	Φ85*80
Driving wheel	mm	φ210*70
Max Lifting height	mm/in	2500/98
Lowered Mast Height	in	82.3
Extended Mast Height	in	120.8
Fork length	in	45.3
Single Fork Width	in	6.3
Overall Width	in	33.5
Overall length (include pedal)	in	97.6
Turning radius	in	67
Driving speed. No-load/full-load	km/h	4.5/3.5
Lifting speed. No-load/full-load	mm/s	120/100
lowering speed.	mm/s	130/150

No-load/full-load		
Climbing gradient. No-load/full-load	°	7/5
Brake mode	Z	Electromagnetic brake
Battery voltage/rated capacity	v/ah	24/80
Driving motor	kw	1.2
Lifting motor	kw	2.2
Net weight	lb.	1421

2. WARNING

1. Without training, please do not drive the electric stacker.
2. Please be aware of surroundings, when operating stacker.
3. Please read and observe the instructions and labels on the stacker.
4. Please check the status of stacker before or after using stacker.
5. Do not stand on the forks.

Safety instructions:

1. Only trained staff can drive the stacker.
2. Please be aware of surroundings, when operating stacker. Otherwise, it may cause dangerous to others.

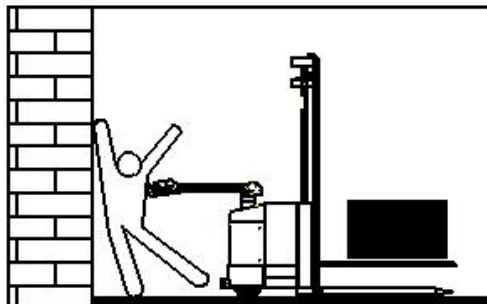

3. When stacker works on the ship or board, please be cautions.

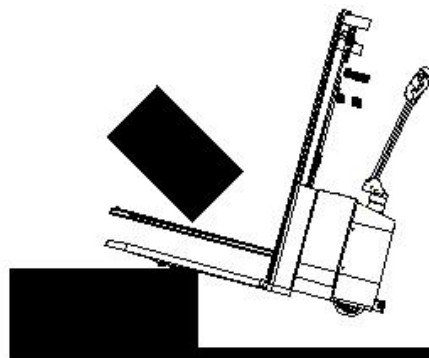

3. NOTICE

1. Please keep away from moving parts of stacker, for example door frame, chain, forks, or wheels.
2. Please drive slowly when passing wet area or rough road.
3. Please be aware of width in order to avoid getting stuck.
4. Please do not drive electric stacker on the road.
5. Please do not carry goods with unstable center of gravity
6. Please be aware of feet, when take a turn.
7. Do not walk under or stand on forks.
8. Please slow down and keep large space with other stacker when passing slippery road.



9. Staff should be in the front of goods when driving pass upslope.
10. When stacker take a turn, power unit will go to the opposite direction because of inertia. Please make sure there is nobody on the corner.
11. When carry cargos, please lower forks to the lowest position. Otherwise, it may cause dangerous.
12. Carrying capacity will decrease when lifting height or distance of load center increases .

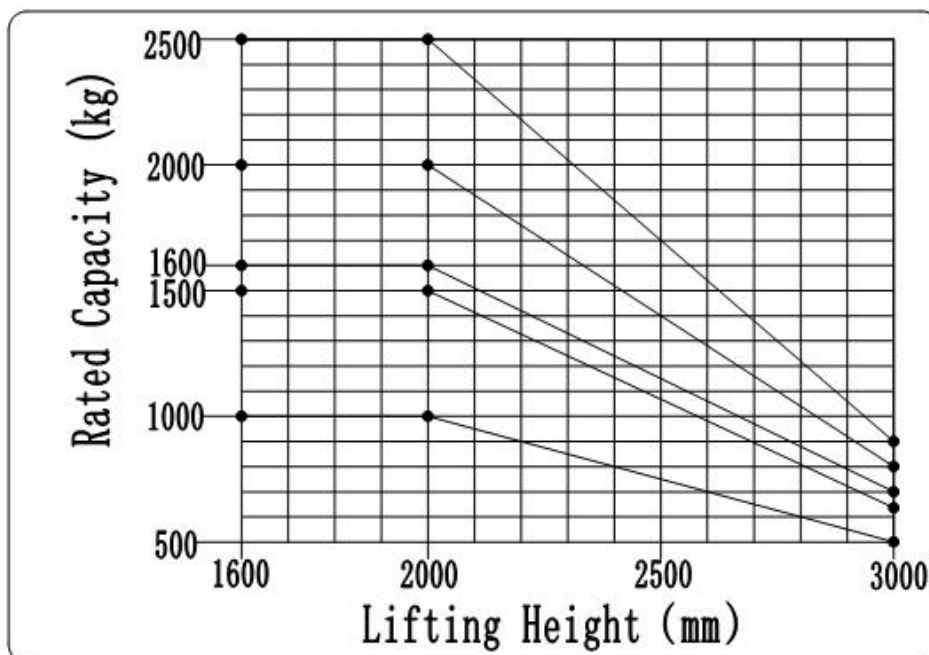

13. Fast driving is dangerous, please drive smoothly. Do not stop or brake suddenly.
14. Before leaving stacker, forks should be in the lowest position, and key switch should be off. Do not park at the slope.
15. Do not use stacker if there is any malfunction. Please hang the dangerous sign on the stacker, and inform serviceman come to fix it. If there is oil or liquid leakage, do not use until it is fixed.
16. In order to avoid explosion, do not use stacker at the explosive atmosphere.
17. Do not carry any goods that the center of gravity is deviate or it is messy.
18. Please check the rated capacity of elevator, before drive stacker into it.
19. Do not use any additional equipment that may affect stacker stability.

4. CONTROL PART

4.1 Emergency stop button

Press down emergency stop button will cut off power, but not turn off power completely. If there is any malfunction, please press down emergency stop button, and then tell your manager.

4.2 Key switch

Rotate key clockwise is on, otherwise, will be off. Please keep off when leave stacker.

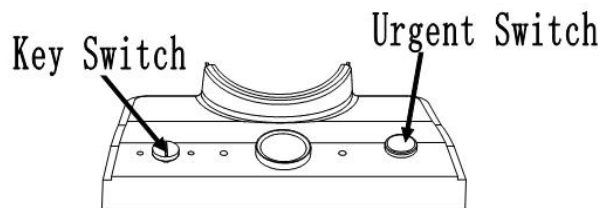

4.3 Control handle

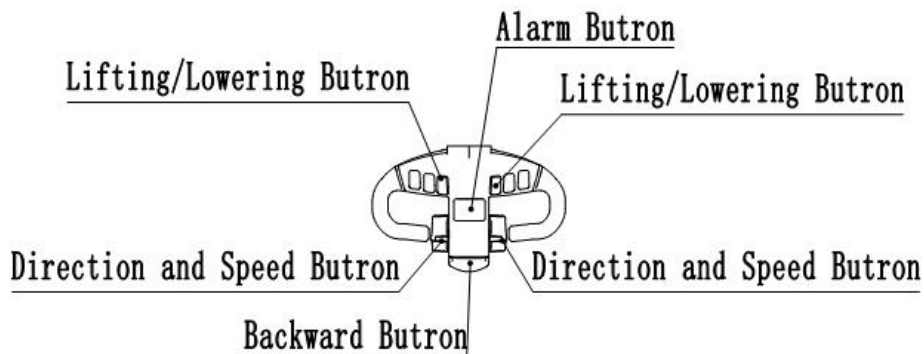

1. Alarm

Alarm button is on the bottom of control handle, and it is used to remind people to keep distance with the stacker, especially passing a corner.

2. Anti-collision button

Anti-collision button is on the top of control handle. When press down this button, the stacker will back off a little to avoid collision. This function is used to prevent operator to be nipped.

3. Direction and speed button

Direction and speed button is on the both side of control handle, which is used to control the direction and speed of stacker. When you rotate button clockwise, stacker will go forward. When you rotate button anticlockwise, stacker will go backward. The speed is depend on the range that you rotated. A large rotation will accelerate the stacker.

4. Lifting and lowering button

Lifting and lowering button is on the upper of control handle, and it is used to control forks up and down.

4.4 Voltammeter

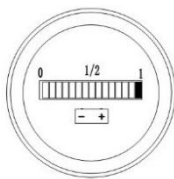

Sufficient Power

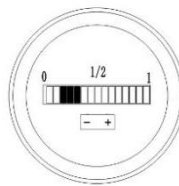

Charging Needed

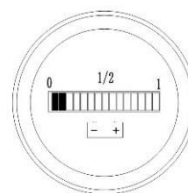

Low Power

4.5 Battery

When you want to check, charge, and change battery, please pull out the plug first. It is easy to open the cover, but be careful of your fingers. Battery is located between door frame and car body, and the both sides of battery is fixed by steel plate. If you want to change battery, you can take out batteries after opening battery cover. However, in order to avoid loose, please use steel plate to fixed batteries after changing.

Storage Battery Instaued Here

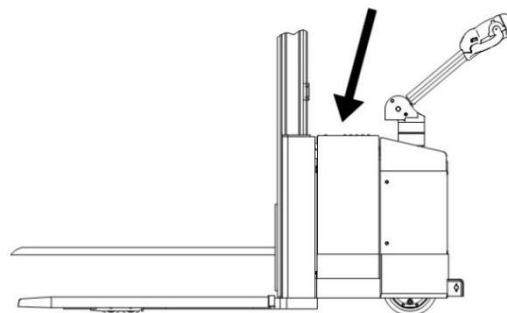

5. STACKER INSPECTION

5.1 Running stacker over and over again

1. Check whether battery is fully charged, and whether electrolyte level is met standard. Do not check electrolyte at flammable atmospheres.
2. Make sure that wheels is well.
3. Check whether lifting chain is damaged.
4. Check whether hydraulic oil is leakage.
5. Check whether control device works well.

5.2 Running stacker at wide-open area

1. Test all function of hydraulic function
2. Test whether handle works well for controlling direction
3. Test whether moving parts works well when driving stacker forward and backward.
4. Test braking distance when driving forward or backward. If braking distance is too long, please contact serviceman to fix it.

5.3 Check hydraulic oil

Regular checking hydraulic oil in order to keep it enough.

5.4 Check battery

1. Check the cover of battery to avoid looseness of bolt.
2. Check the proportion of electrolyte.
3. Check whether the terminal of batteries are loose.

6. STACKER OPERATING INSTRUCTIONS

6.1 Power unit

Please operate control handle slightly to let stacker runs at a constant speed.

6.2 Start

1. Turn off emergency stop switch
2. Turn on key switch

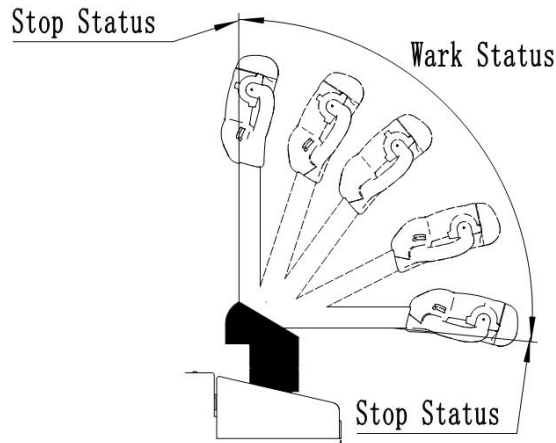

6.3 Driving

Use handle to control speed and direction.

6.4 Slow down

Release speed and direction button, stacker will slow down automatically.

6.5 Brake

The function of brake can be achieved by let control handle locate at highest or lowest position.

6.6 Lifting and lowering

Press lifting and lowering button until the forks met the required height.



Lifting

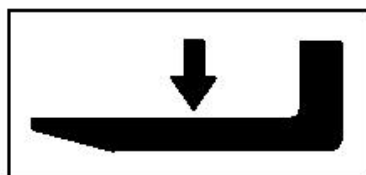

Lowering

6.7 Unload

When close to the storage area, please slow down and lifting cargos to the height of shelves.

6.8 Load

When close to the storage area, please slow down and park at the front of cargos. Move forks under the tray, and then lift cargos.

6.9 Storage

Please park stacker at the specific area; lower forks to the lowest position; turn off power; and then lock by the key.

6.10 Long-term parking

1. Please park at a dark area, and unplug the plug to avoid the loss of power.
2. Please coated moving parts with oil-proofing agent, such as plunger and carriage axle.
3. Start stacker once per week, and lifting or lowering forks.
4. Charging once per month.

7. MAINTENANCE

7.1 Repair summer

1. Keep stacker in good working condition.
2. Please use original spare parts when repairing and changing.
3. Please use same type of oil when adding or changing oil.
4. Do not let any staff that without training to repair stacker.
5. Please maintenan on time.
6. Record the time of maintenance.

7.2 Announcement

1. Do not smoke when maintaining.
2. Please turn off key switch, and unplug of the plug when doing service.
3. Do not use water to clear stacker directly, but use compressed air to clean electric parts.
4. Do not put foot, hands, or any part of body between stacker and goods shelves.
5. Please check stacker before using in harsh conditions.

7.3 Maintenance

Maintenance of machine		Interval	
		2 month	6 month
1	Check whether fastener is loose	√	
2	Check whether oil tube connection is leak	√	
3	Check whether gear case has noise or leak	√	
4	Check whether lifting system works well	√	
5	Check whether forks have crack or deformation		√
6	Check whether under pan has crack or deformation		√
7	Check whether wheels have abrasion or damage		√
Maintenance of hydraulic			
1	Check whether hydraulic oil cylinder has abrasion, noise, and damage		√
2	Check whether hydraulic adapting piece and oil tube have damage or leak	√	
3	Check whether oil level meet the standard		√
4	Check and adjust pressure valve's function (+10%) load		√
Maintenance of electric appliance			
1	Check whether cable, connector, and terminal connect well		√
2	Check the function of emergency stop switch	√	
3	Check whether motor drive system works well	√	
4	Check whether alarm and safety device works well		
5	Check whether use correct fuse	√	
6	Check whether contactor, display, and buzzer work well	√	
7	Check whether control system works well		√
8	Check whether electric system works well		√

8. BATTERY SERVICE AND MAINTENANCE

1. Specification of battery

Battery		Charger
Rated voltage: 24V	Rated capacitance: 80 Ah	Output: 24V 10A

2. Please use cotton cloth to clean battery after charging, and keep it clean and dry.
3. Do not over charge or discharge, and also do not quick charge or under charge..
4. Do not put any conductor on the battery.
5. Please check, maintain, or change battery when any batter unit is broken.
6. Please tightening connecting parts.
7. Please keep ventilation, and do not smoke or have open fire when charging.
8. When acid splashed on the cloth or skin, please use plenty of water to wash it.
9. Please keep dry and clean of nut on each battery unit; tightening every terminal and cable end, and then coated with grease in order to avoid corrosion.
10. Do not heavy load discharge, for example, driving and lifting at same time.
11. Please add some water when electrolyte level is lower than stander.
12. Please charge immediately (Do not over 24 hours), when battery is fully discharged or charging signal is on, otherwise, it may shorten the service life of battery. If not use tow truck for a long time, please charge once per month. Do not over charge or over discharge, in order to avoid battery damage (charging time: 8 hours).

9. MALFUNCTION ANALYSIS AND SOLUTION

Malfunction	Cause	Solution
Voltmeter has no display after opening electric door lock	The fuse of electric system is burn out or the electric door lock is damaged	Change fuse or electric door lock
Hydraulic station and motor pump have noise when working	The magnetic valve of hydraulic station is dirty	Clean magnetic valve
	Oily is too high	Use low oily hydraulic oil
Cannot lift cargo	Overload	Check rated load
	The Oil cylinder pressure is not enough	Check or change sealing element
	Low level of hydraulic oil	Refill hydraulic oil
	The fuse of lifting is burn out	Change fuse
	Low battery	charge
	Lock the electric door lock or turn on the emergency stop switch	Unlock the electric door lock or turn off emergency stop switch
Cannot lower forks	The magnetic valve of hydraulic station lost control.	Clean or change
	Mast roller is stuck	Adjust or change
	Inner gantry mounting is oversize deformation	Adjust or change
	Oil return hole is blocking	Clean