



## Fryers

Eurodib Gas Range answers the needs of modern, busy catering establishments for reliable, well built equipment that offers flexibility, performance, style and value for money. Eurodib equipment has been designed with safety, ease of operation and performance as paramount. The gas series has a stylish and robust modular design, constructed of high quality brushed stainless steel, large “cool to touch” dials, large heavy duty adjustable feet and easy to clean accessories.

The Eurodib Fryers are compact, easy to operate counter top fryer which complements the Eurodib range. Fries, chicken or seafood the Eurodib fryers can meet your deep frying needs.

## Product Features

- Stainless steel construction and finish
- Stainless steel tube style tank
- Thermostat controls
- Flame failure
- Stainless steel burners
- Burner safety valves
- Piezo ignition and pilot light
- Heavy duty fryer baskets
- Attachable drain connection to facilitate draining down
- Heavy duty adjustable feet
- 3/4" rear gas connection



## Gas Fryers



CF10

# Gas Fryers

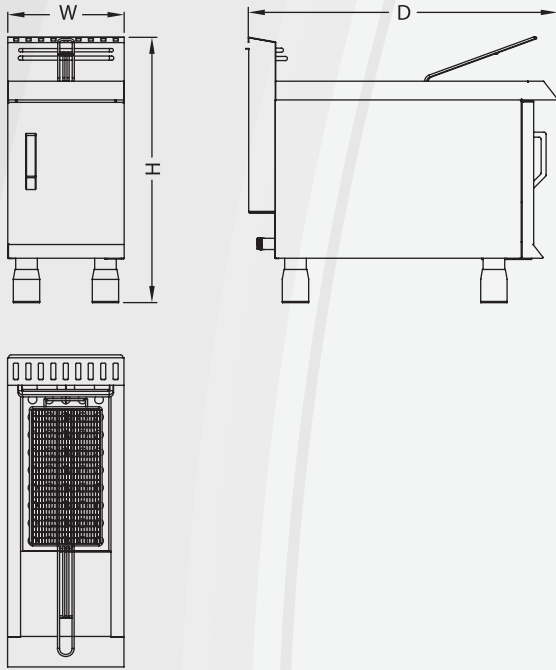

Product Code	Open Burners	Capacity/ Cooking Area	Btu/hr Total	Product Overall Dimensions (inch)		
				Width	Depth	Height
<b>CF15</b>	2	15lb	NAT 26500	11	29.1	25.2
<b>CF30</b>	4	30lb	53000	17.3	29.1	25.2



- 3/4" male rear gas connection, all units fitted with Natural gas only
- Installation: Allow 4" for gas regulator at rear of unit

- Warranty: 1 year Parts and Labor