



Demand the best. Demand Dynamic.

PROJECT

ITEM NUMBER

QUANTITY

SMX450ES

SMX SERIES

IMMERSION BLENDERS



REFERENCE

- MX043.1ES (115V)
- MX043ES (230V)

DESCRIPTION

THE DYNAMIC SMX450ES ENHANCED SERIES IMMERSION BLENDER WILL MIX, BLEND, PUREE OR EMULSIFY UP TO 30 GALLONS / 115 LITRES IN JUST A FEW MINUTES. NEW MOTOR DESIGN FOR INCREASED EFFICIENCY.

FEATURES

- 600 WATTS
- 11000 RPM
- 16" STAINLESS STEEL FOOT
- 12.6 LBS
- SAFETY SWITCH
- DETACHABLE BELL
- TITANIUM PLATED CUTTER BLADE
- GOOD FOR UP TO 30 GALLONS / 115 LITRES OF MIXING
- 1 YEAR PARTS AND LABOR WARRANTY

SHIPPING INFORMATION

- SHIPPING WEIGHT: 16 LBS
- SHIPPING BOX DIMENSIONS
- LENGTH: 10.75" (273.05MM)
- WIDTH: 6.75" (171.45MM)
- HEIGHT: 40.5" (1028.70MM)
- CUBIC MEASURE: 1.70 FT³ (0.048M³)

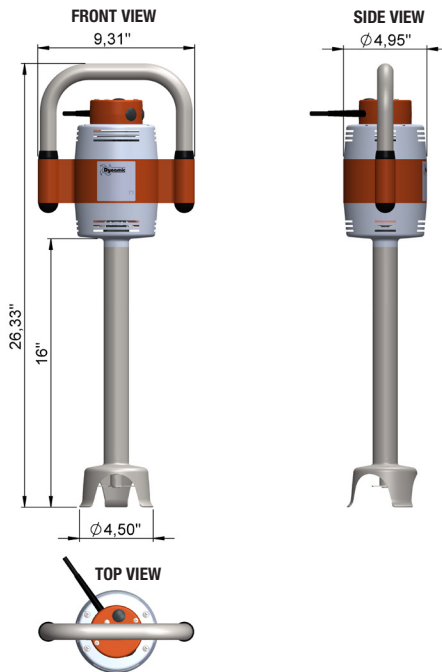

WARRANTY POLICY

Dynamic will guarantee all new Dynamic products to be free from defects in materials & workmanship. Electric products - Includes a 1 year parts and labor carry in bench warranty; with the exception of component replacements necessary through regular "wear & tear". Manual products include a 1 year limited parts warranty. Warranty is valid, providing the products have been used in accordance with Dynamic's operating recommendations & guidelines. Dynamic or any authorized service center will repair or replace, at our discretion and after examination, any or all manufacturer's defective parts during the warranty period. Any damage caused by improper use, abuse, dropping, or similar accidental damage resulting in breakage will render the warranty null and void. During the warranty period, only Dynamic or one of its authorized service centers may perform evaluations or repairs to products. Warranty will be void on any equipment which has been dismantled or tampered with during this warranty period if this has been done by unauthorized centers or personnel.



Phone (800) 267-7794 | Fax (877) 668-6623

info@dynamicmixers.com

www.dynamicmixersusa.com | www.dynamicmixers.ca