

Cookline ER24-240 24" Electric Range with 4 Burners, 240V



FEATURES

- Electric hotplate, 2.6kw and 2kw combination
- Thermostat (140°F- 500°F) controlled oven
- Spacious static oven cavity
- Adjustable heavy duty legs
- Stainless steel oven door
- Separate controls on the oven
- Adjustable heavy duty legs
- 4 sealed burners
- Independent heat controls
- 2 Racks per oven standard
- 6" adjustable legs included
- Handy back shelf
- Crumb tray
- 3 Phase (convertible to 1)
- Kick plate at the bottom for easy access for servicing

cCSAus

USR Brands Group is a US supplier of premium quality commercial cooking, refrigeration and food preparation equipment. Our aim is simple. Produce industry-leading commercial restaurant equipment at reasonable prices, and back it all up with an easy to understand, no nonsense warranty that people can count on.

For Commercial Use Only

TECHNICAL DATA

DIMENSIONS

Exterior Dimensions	24"L x 31.5"D x 56.5"H
Oven Dimensions	20.63"L x 25"D x 13.85"H
Packaging Dimensions	28.3"L x 40.5"D x 35"H
Unit Weight	291 lb
Shipping Weight	334 lb.

ELECTRICAL

Voltage/Phase/Wattage/Amps	240V / 1PH / 13.6Kw / 56.6 Amps
	240V / 3PH / 13.6Kw / 32.3 Amps
Hertz	60
Plug Type	Hardwire

COOKING

Numbers of Burners	4
Burner Heat Element	2Kw ~ 2.6Kw
Burner Style	Sealed Round Plate
Burner Diameter	7 3/8 - 8 7/8"
Oven Style	Standard Oven
Numbers of Ovens	1
Max. Oven Temperature	550°F
Numbers of Oven Racks	2
Oven Heat Element	3 + 1.4 Kw

CONSTRUCTION

Frame Structure	Welded
Number of Legs	(4) Qty: 2 with brakes, 2 without
Pull Out Tray	Yes

TECHNICAL DRAWING

MODEL: ER24-240

MFR MODEL:

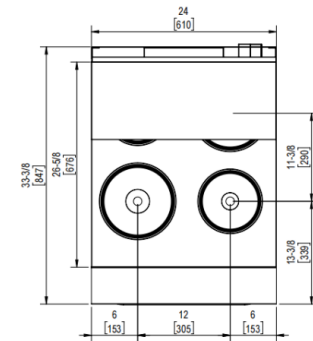
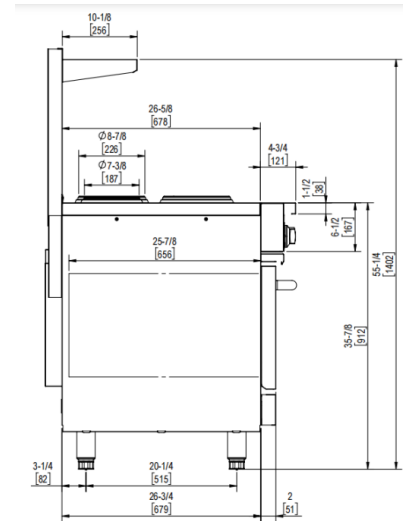
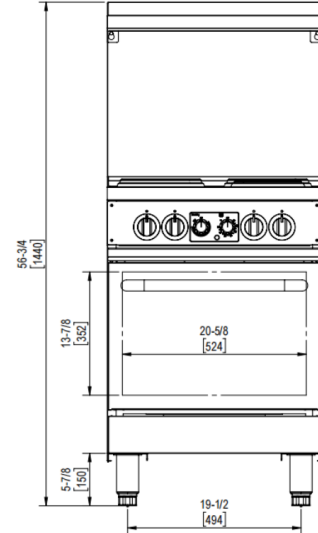

WARNING: High wattage unit, independent circuit breaker required!