



Stainless steel cabinet construction

Stainless steel interior and exterior (galvanized steel back & bottom).



Temperature range between 33°F ~ 39°F

Air guard on rear wall ensures proper air circulation and cooling.



Hydrocarbon refrigerants (R-290)

Increases energy HFC refrigerants. It is safer for the environment and does not cause ozone depletion.



Visual and audible door open alarm

Alarm sounds when doors are not completely closed to protect against food spoilage



Cabinet Dimensions (inches/mm)

L	D	H
60 1/2"	33"	35 29/32"
1537 mm	839 mm	912 mm

Weight (lbs/kg)

Net Weight	Ship Weight
247 lbs 112 kg	304 lbs 138 kg

Cabinet construction

- Cyclopentane Insulation – Contains no hydro-fluorocarbons (HFCs) and is environmentally friendly.
- Epoxy coated wire shelves with adjustable shelving height.
- 2 shelves per compartment.
- Four 4" Diameter swivel casters with front brakes standard.

Refrigeration

- Self-contained system, rear mounted compressor.
- Electrodeposition coated evaporator increases performance by maintaining the heat transfer rates over the life of the evaporator and reducing potential corrosion.
- Innovative hot gas frame heating system reduces condensation and increases energy.

Design & Features

- Self-diagnostic digital temperature control & monitor system.
- Digital display allows for easy monitoring.
- Digital controls include manual defrost for easy maintenance.
- Rounded corner design gives a stylish appearance and reduces chances of injury.

Doors

- Self-closing doors
- Durable door gasket with easy replacement.
- Lifetime guaranteed heavy duty all metal door handles. (Ni-Cr Plated)

Optional Features & Accessories

- 2.5" diameter casters available.
- Additional shelves are available.
- Back splash guard and drawer models available

Front view

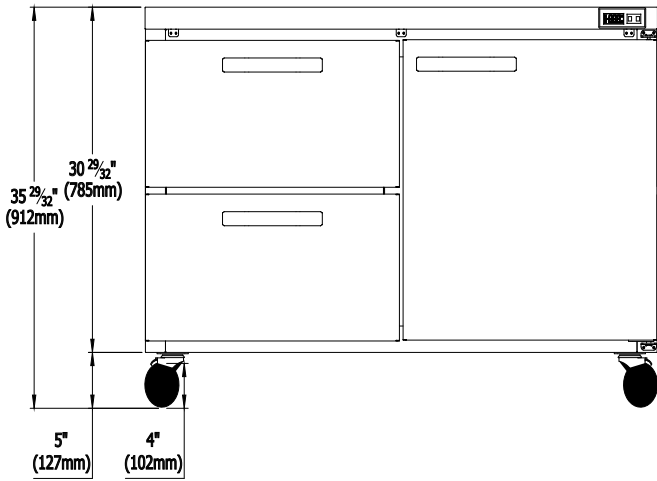

Pan Configuration

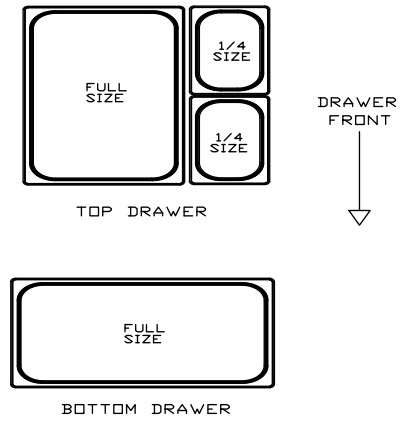

Side view

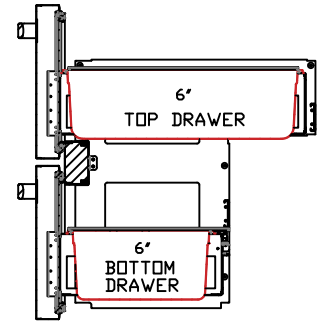
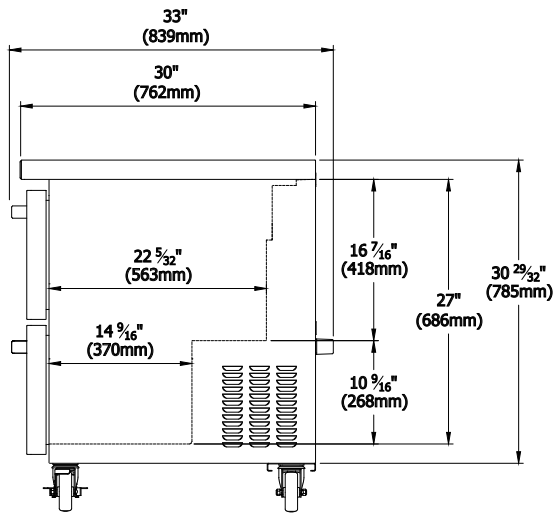

Drawers accommodate 6 inch pans

Top view

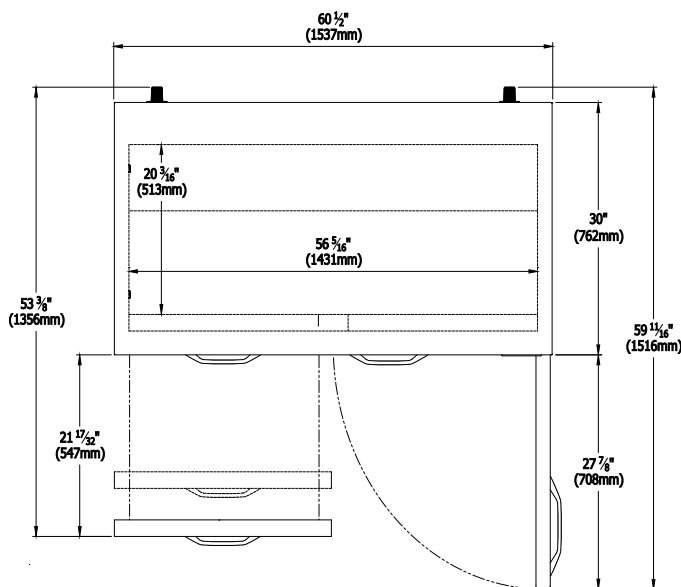

Drawers	2
Capacity Cu.Ft.	13.1
Shelves	1
Refrigerant	R-290
Temperature Range	33°F ~ 39°F
Easy Maintenance	Sliding Condensing Unit
Connection	9.8 ft long (3m) flexible three wire cord with modeled plug
HP	1/4 HP
Voltage	115V/60Hz
Amps	4.7
NEMA Config.	NEMA 5-15



- This product may expose you to chemicals including Diisononyl Phthalate (DINP), which is known to the State of California to cause cancer. For more information go to www.P65Warnings.ca.gov.
 - Ce produit peut vous exposer à des agents chimiques incluant le Diisononyl Phthalate (DINP), reconnu par l'Etat de Californie comme causant le cancer. Pour de plus amples renseignements, consulter le site www.P65Warnings.ca.gov.



Conforms to NSF/ANSI 7 (ETL)

Blue Air has right to change specifications without further notice.

